



Standard Graver Sharpening Fixture

INSTRUCTIONS • PART #003-100

The GRS Standard Sharpening Fixture provides a convenient method for fast, accurate and consistent graver sharpening. It is most effective when used with the GRS Power Hone, but may also be used with a stationary bench stone using a sweeping action.

To use:

1. Set the desired angle (FIG. 1) for the face of the tool.
 - 45° for most purposes
 - For cutting very hard materials, use 50° or 55°
 - For softer material, use less angle - 45°

Experience will teach you the best angle for your purposes.

2. Clamp graver in fixture by depressing top clamp lever (FIG. 2). Locate square or traditional gravers properly in the V-grooves (FIG. 3 & FIG. 4).

3. Place fixture and guide post assembly near the stone or Power Hone lap to sharpen the face angle. Power Hone users, make sure the wheel area is turning away from the tool and not into the tool. Sweep the tool point across face of stone or lap (FIG. 5). Use downward pressure to speed cutting action.

4. Inspect to assure a sharp point. To reduce sharpening time, remove excess material behind the point on a bench grinder prior to sharpening. (Do not overheat tool on bench grinder. Constantly dip tool in water to keep it cool while grinding.)

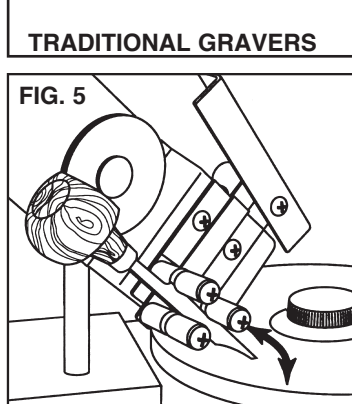
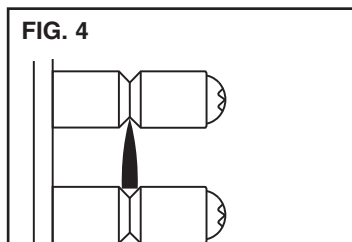
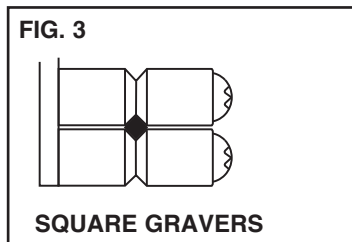
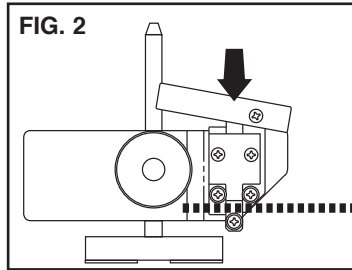
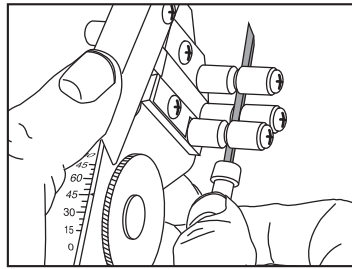
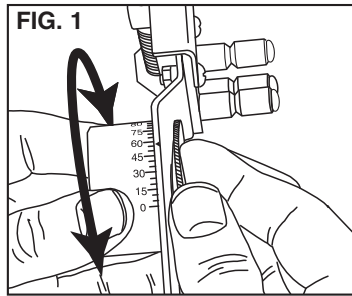

5. If desired, polish the point by changing to a finer wheel or ceramic lap on the Power Hone. If using a flat stone, switch to a finer stone or polishing paper. Some prefer to polish freehand. Polishing improves the appearance of the cut and creates a sharp point that lasts longer.

6. An excellent and consistent heel can be put on a square graver with this fixture. Most other gravers are best heeled by the freehand method.

FIG. 6

SQUARE GRAVER

Sharpen with sweeping motion back and forth across wheel. Use the wheel area turning away from tool ... not into tool.

- A. Set angle at 10° or 15° depending upon desired heel angle.
- B. Clamp tool in fixture across the graver flats, not in the V-grooves (FIG. 6).
- C. We recommend making the heel by sweeping the graver once or twice across the diamond wheel WITHOUT turning the Power Hone on -OR- sweeping across a fine bench stone.
- D. Rotate the graver 90° in the fixture and heel the other side the EXACT same way. When using two sweeps on one side, use two sweeps on the opposite side.
- E. Take care to remove equal amounts off each side for a uniform heel. Polish the surface to obtain a bright cut. Diamond Spray on a piece of leather works very nicely for polishing.

To Radius-Heel a Flat Graver

After grinding the desired face angle, turn graver over 180° and clamp into fixture (FIG. 7). With the clamp screw loose, rest tool against wheel or stone as shown in (FIG. 8). Now, lift the fixture up the post, letting it pivot, while keeping the tool against the wheel or stone (FIG. 9). A straight flowing motion will give the best results.

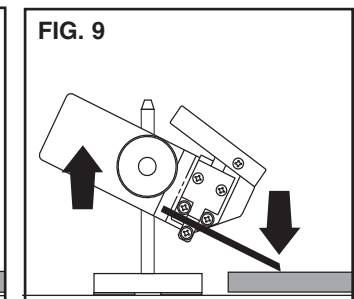
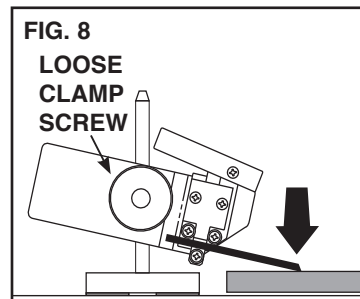
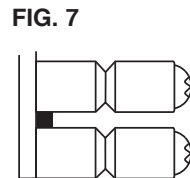

GRS Standard Graver Sharpening Fixture

PARTS LIST • PART #003-100

003-100 PARTS LIST

1	003-038	Base Plate-Formed
2	003-504	Clamp Screw Assy.
3	003-118	Post
	002-290	#10-32 x 3/4 FHMS
4	003-116	Lever
5	003-111	Slide Plate
6	002-061	#8-32 x 3/8" RHMS
	002-110	#8 Washer
	002-064	#8-32 Hex Nut
7	002-062	#8-32 x 1/2 RHMS
	002-110	#8 Washer
	002-064	#8-32 Hex Nut
8	003-108	Pivot Guide
9	003-113	Retainer
10	003-107	Guide
11	050-011	0.060" x 1" Strip Magnet
12	003-117	Base Plate
13	003-109	Slide Plate Pin
14	003-115	Spring-Sharpening Fixture
15	003-110	Spring Retainer
16	003-106	Degree Guide
17	003-066	Locator Shim
18	003-119	Locator
19	002-102	#8-32 x 1 3/8" RHMS
	002-110	#8 Washer
	002-064	#8-32 Hex Nut
20	002-110	#8 Washer
21	002-054	Roll Pin 3/16" x 1 1/4"
22	002-106	1/4" Washer

