



GraverMeister 915 Handpiece

INSTRUCTIONS • #004-915

ADJUSTING THE HANDPIECE

First connect the handpiece hose to the Gravermeister. With it turned on, point the handpiece nose up and unscrew knob until it strokes with no throttle. Screw the knob in until you hear it stop stroking. Turn the knob in about 1/2 turn and this is the proper adjustment for the handpiece. Tighten the locking ring to the knob. Adjust the handpiece each time you clean it.

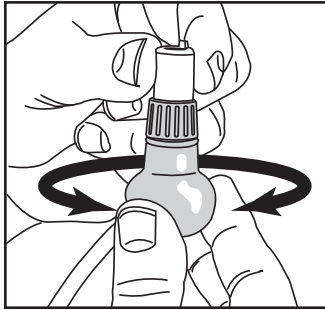
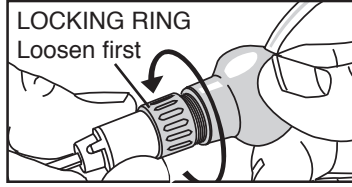

Unscrew knob until the handpiece strokes without using throttle.

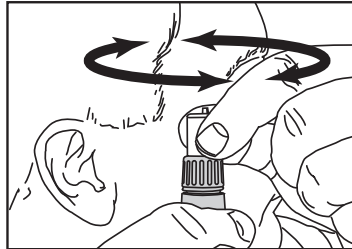

Hold to your ear and turn knob until you hear it stop stroking. You can feel it stop too. Turn knob in about 1/2 turn and tighten the locking ring.

HOW-TO-ATTACH A NEW HOSE

Loosen the locking ring and remove the knob from the handpiece. Remove the old hose by cutting it off close to the knob. With a small punch, push the hose/brass fitting back into the knob body. Remove the brass fitting (#004-409) from the cut off hose piece. Feed the new air hose through the hole in the knob (FIG. 1). Insert the brass fitting into the end of the hose making sure it is fully seated. Moistening the fitting first may help it slip into the hose easier. Then apply a small amount of moisture or oil (you can even use "skin oil" from your nose or forehead) around the outside end of the hose next to the brass fitting and pull the hose back (FIG. 2) into the knob until you see the tip of the brass fitting protrude through the side of the knob. This must be an airtight fit, so you will have to pull somewhat hard (a few pounds, at least).

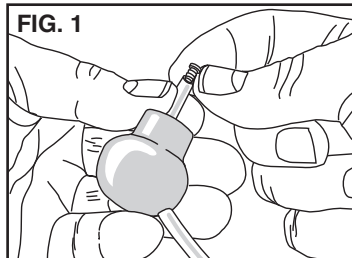

Note: A shorter hose can help boost power.

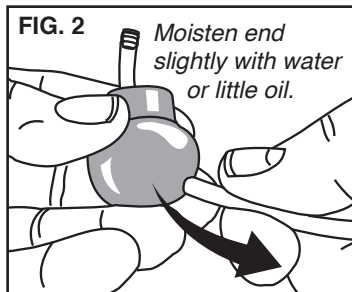

PUTTING A FLAT ON A HANDPIECE KNOB

If you choose to put a flat on the knob you should use the handpiece first to be sure where the hose "exit" is most comfortable for you. Note critical dimensions below and warnings.

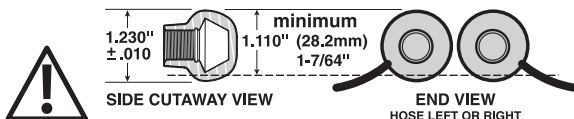

IMPORTANT: If too much material is removed, knob will be ruined (#004-404). This is NOT covered by the warranty.

915 MAINTENANCE

The only basic maintenance for the 915 is keeping the inside clean. Problems will occur if oil or moisture get into the handpiece, especially on the piston. If you notice a loss of power or erratic performance, the first thing to check is that the receiver (chuck) is tight in the handpiece body. With a graver inserted in the QC Holder, use a crescent wrench or pliers to gently tighten the receiver clockwise (FIG. 3). If the problem continues, disassemble and clean handpiece.

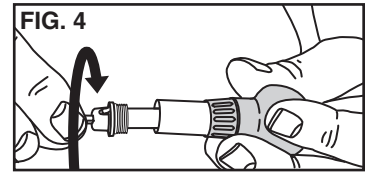
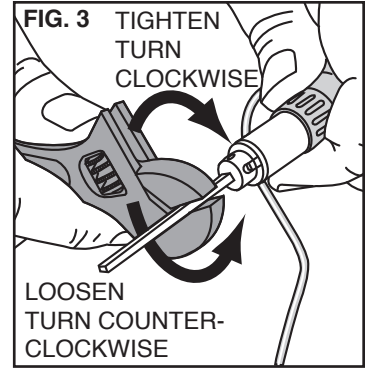

DISASSEMBLY: Use the crescent wrench or pliers to grip the graver (FIG. 3) and turn it counterclockwise to loosen the receiver (chuck). Turn the chuck retainer with your fingers (FIG. 4). As you pull out the chuck, there will be a piston and spring that follow. Loosen the locking ring and remove it (FIG. 5). Grip the knob and turn the handpiece body counter-clockwise until it separates (FIG. 6).

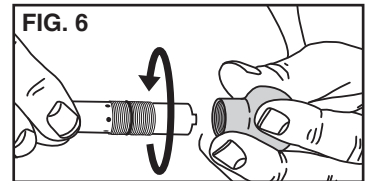
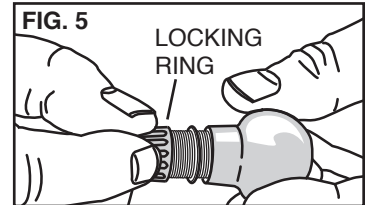

Clean the parts with a non-residue solvent like denatured alcohol. Make sure the holes in the handpiece body are clear from debris. Do not get moisture down the air hose. If this happens, you will need to clear and dry it before reassembly. Make sure every thing is completely dry before reassembling. **DO NOT oil inside the handpiece; lubrication decreases performance.**

REASSEMBLY NOTE: There is an O-ring inside the knob that makes getting the handpiece body to thread a little difficult when reassembling. Use a very small amount of synthetic lube or non-stick grease and create a thin film around the **OUTSIDE** of the shaft between the threads and the end (FIG. 7).

QUICK CHANGE HOLDER HINT

Synthetic Lube or non-stick grease on the shaft of a quick change holder will make them easier to slip in and out.

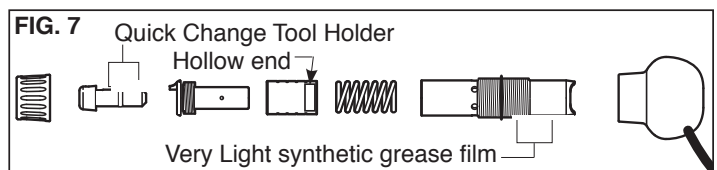

NOTE: Do NOT use petroleum based oils - USE ONLY Synthetic oils. Fossil oils can damage the O-Rings.

GRS QC 915 Handpiece For GraverMeister

PARTS LIST • #004-915

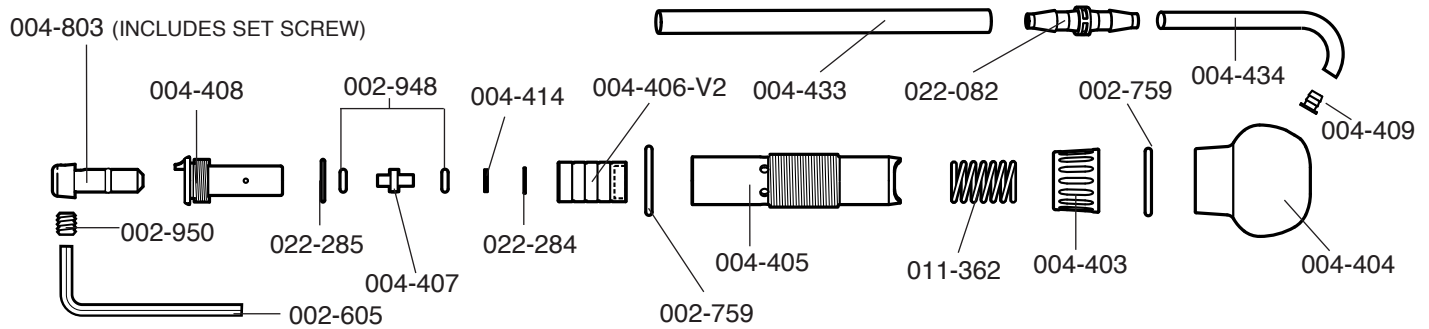

Part No.	Description	Part No.	Description
002-605	Hex wrench	004-434	Air hose - 3/16" OD x 1/8" ID x 20"
002-759	O-ring 1/2" ID x 1/16" wide	004-430	Fine Work Spring
002-948	O-ring 1/8" ID x 1/16" wide	004-433	Air Hose - 1/4" OD x 0.167" ID x 20"
002-950	Set screw	004-803	Quick Change chuck (complete with set screw)
004-403	Locking nut	011-362	Spring
004-404	Handle knob	022-082	Tube coupling
004-405	Handpiece body	022-284	Internal retaining ring
004-406-V2	Piston/hammer	022-285	O-ring 10 mm ID x 1 mm wide
004-407	Anvil		
004-408	Chuck receiver		
004-409	Air hose retainer		
004-414	Washer		

GRS High Speed Valve Kit For GraverMeister • #001-893

GET THE MOST OUT OF THE 915 HANDPIECE

The GRS 915 Handpiece has a wide power range. If your Gravermeister is an 800-1200 stroke version, you will not be able to use the FULL capability of the 915 handpiece. To get the most out of your handpiece, upgrade the 800-1200 stroke version Gravermeister with the High Speed Valve Kit. With the faster 1600-2400 impacts per minute, you will get the full use of the 915 and have smoother cuts, longer tool life, and reduced work time. Ask your sales representative today!

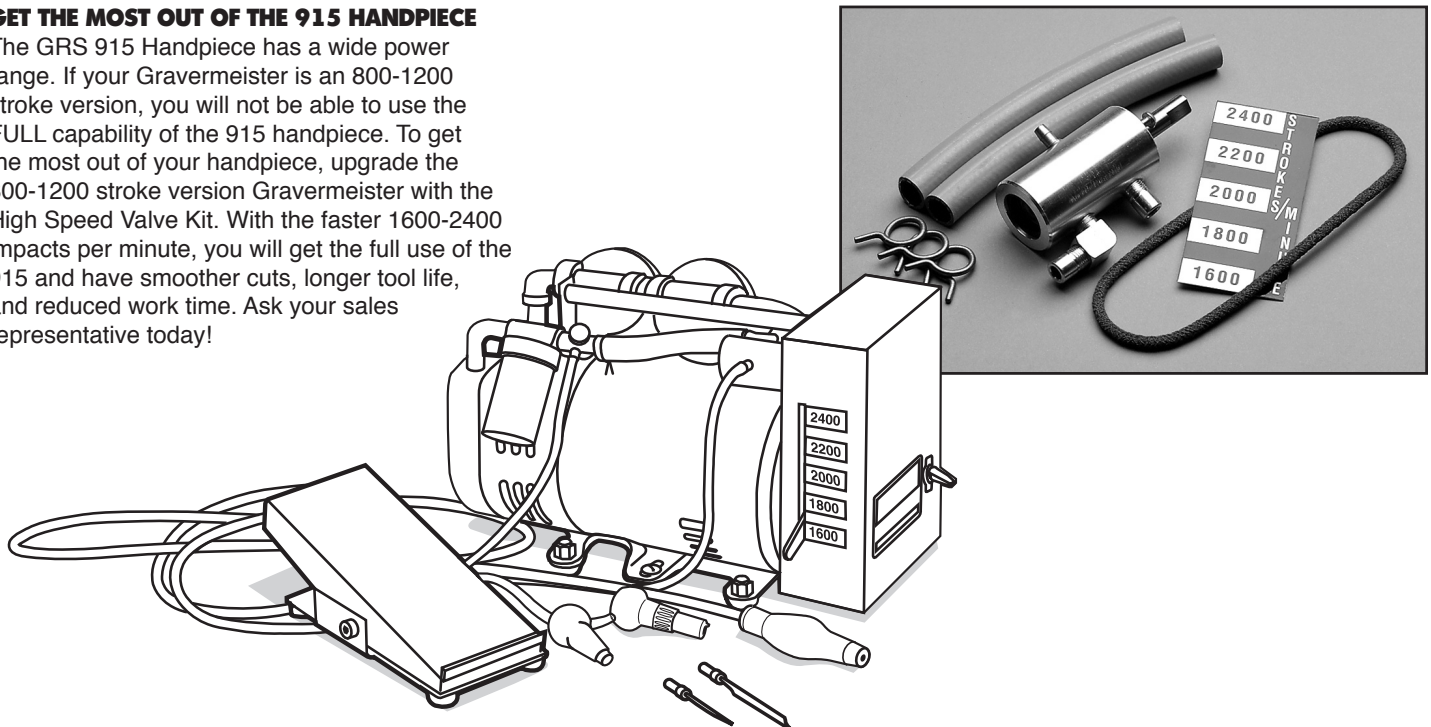

GLENDO CORPORATION

900 Overlander Road • Emporia, KS 66801 USA
 800-835-3519 • 620-343-1084 • Fax: 620-343-9640
 grs@grstools.com • www.grstools.com
 Last Updated: March 20, 2014